

BT8390-WFK4

SYSTEM X™ WALL-TO-WALL RAIL MOUNTING BRACKETS

The BT8390-WFK4 is a bracket designed to fix BT8390 V2 mounting rails between opposing walls, for the installation of menu boards and other multi-screen configurations. The plates fix the ends of the rail to the wall at a 90° angle, and are ideal for installations where the back wall is not present or is unsuitable for mounting.

SPECIFICATIONS

Compatible interface arms	Any System X arm
Max load (when used with rails under 2m)	265lbs
Max load (with rails from 2m up to Max. 4m)	176lbs
Distance from wall (to front of rail)	1.4"
Brackets supplied (per pack)	4
Standard max distance between walls	2m*

FEATURES

- 1 Ideal for mounting between opposing walls, the BT8390-WFK4 fits to walls at a 90° angle
 - 2 Can be used with multiple mounting rails to create impressive videowall installs
 - 3 4 mounting plates supplied per kit. 2 plates are used at each end of the rail
 - 4 2m rail length can be exceeded with the use of corner supports
- Designed to allow BT8390 horizontal rails to be mounted between walls
 - When creating video walls, bracing the horizontal rails together is recommended, using an additional rail (mounted vertically)*
 - All mounting hardware included

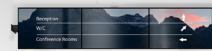
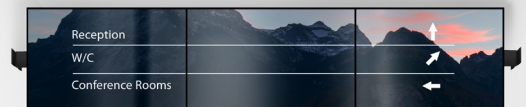

SYSTEM X

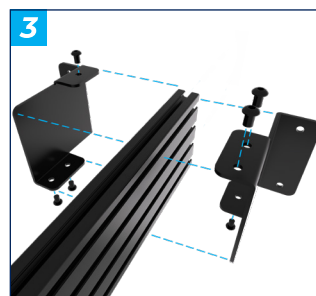
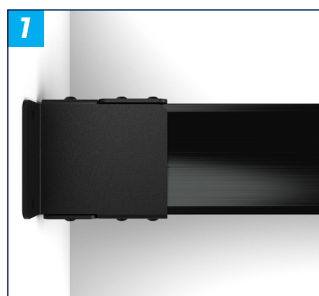

*For larger installs, up to 4m corner supports must be used, contact your account manager for further details

BT8390-WFK4

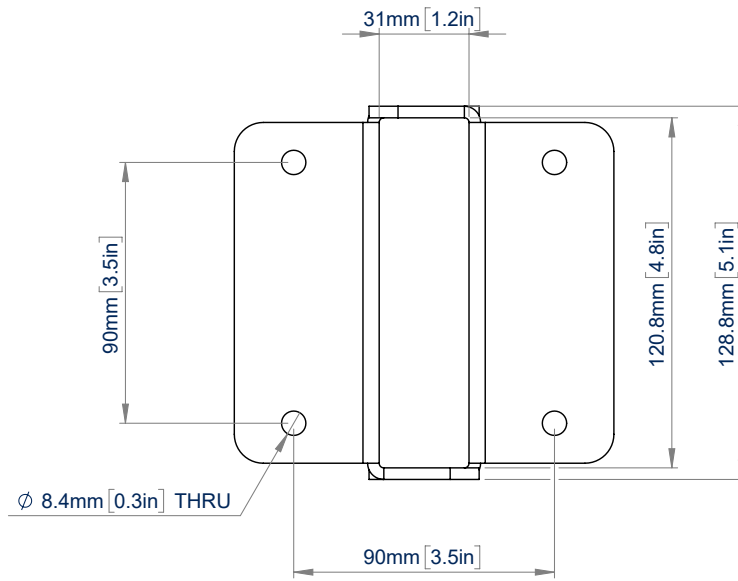

FRONT VIEW

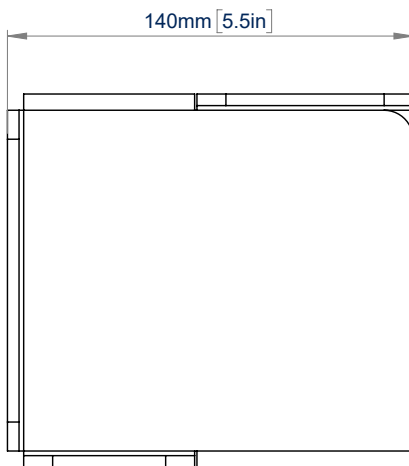

SIDE VIEW

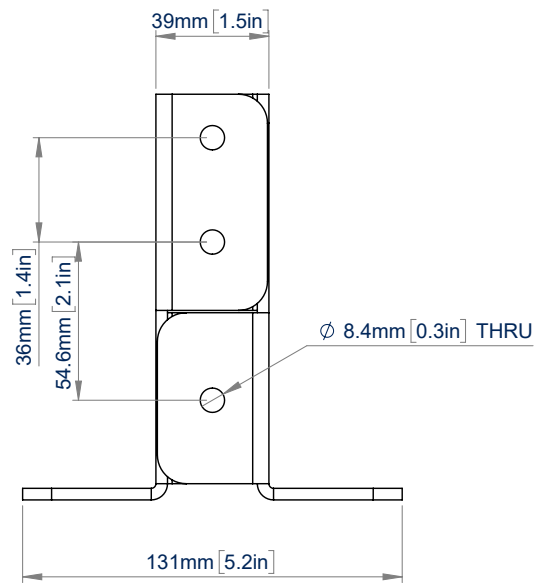

TOP VIEW

ORDERING INFORMATION

COLOR	ORDER REF	BARCODE
Black	BT8390-WFK4/B	5019318759826

RELATED PRODUCTS

PRODUCT CODE	NAME	DESCRIPTION
BT8390	System X Horizontal Mounting Rail	Sturdy mounting rail designed to support a variety of interface arms & mounts
BT8390-VESA200F	Interface Arms	Designed to mount small / medium sized screens vertically to mounting rails
BT8390-VESA400T	Interface Arms with Tilt	Mount medium / large sized screens to mounting rails, with a tilt of +20°
BT8390-VESA400MAF	Interface Arms with Micro-adjustment	Mount video wall screens with the ability to perfectly align displays

© 2025 B.Tech. AV Mounts Co., Ltd. All rights reserved.
 The information in this document is subject to change without notice. B.Tech. AV Mounts Co., Ltd. is not responsible for any errors or omissions in this document. Any reproduction or translation of any part of this document is strictly prohibited without the prior written permission of B.Tech. AV Mounts Co., Ltd.

SS-V4-BT8390-WFK4-070825